

INFORMATION IN THE DRAWING IS FOR REFERENCE ONLY. UNITS OF MEASURE SHOWN IN INCHES UNLESS NOTED OTHERWISE. THE INFORMATION CONTAINED IN THIS DRAWING IS THE SOLE PROPERTY OF DECTRON AND STROHMAIER CORPORATION. ANY REPRODUCTION IN PART OR AS A WHOLE WITHOUT THE WRITTEN PERMISSION OF DECTRON OR STROHMAIER CORPORATION IS STRICTLY PROHIBITED.

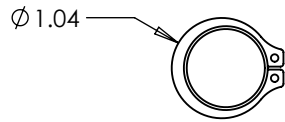

2X REMOVEABLE EXTERNAL RETAINING RINGS TO SECURE ASSEMBLIES (INCLUDED)
*** external retaining ring pliers required*

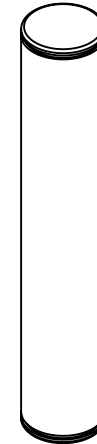
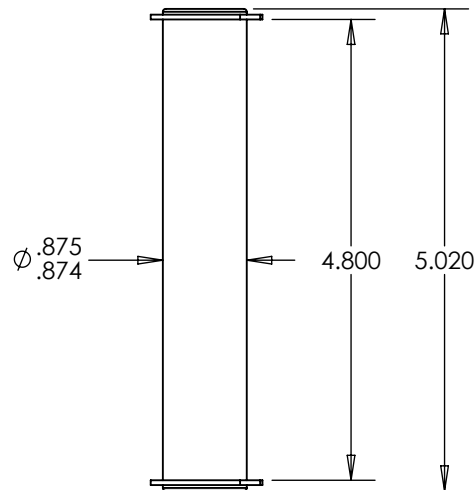

DECTRON USA

PART#

70-0049-00

DESCRIPTION

CONNECTOR PIN, 5.0" LENGTH